

DESCRIPTION

An economical differential switch utilizing a simple and reliable design. It is used for many monitoring applications such as a filter change indicator. Constructed of an anodized aluminium body with steel ports for durability.

FEATURES

- Snap action micro switch
- Factory set or field adjustable
- Diaphragm design

APPLICATIONS

- Filter element monitoring
- Fluid control
- Water treatment applications

Specifications

Electrical	5A [12/24 VDC, 125 VAC] or 3A [250 VAC]
Switch Type	Snap Action
Protection	DIN 43650A - IP65, Terminals - IP00
Mechanical Range	1,000,000 Cycles @ 75 PSI (5.2 BAR)
Media Temperature Range	Nitrile: -20°F to 180°F (-29°C to 82°C) Viton: 23°F to 248°F (-5°C to 120°C) HNBR: -20°F to 248°F (-29°C to 120°C) EPDM: -20°F to 248°F (-29°C to 120°C)
Ambient Temperature Range	-40°F to 180°F (-40°C to 82°C)
Diaphragm Material	Standard: Nitrile Optional: Viton, EPDM, HNBR
Housing Material	Anodized Aluminum Housing
Maximum Overpressure	500 PSI (34 BAR)
Repeatability	+/- 2% of full set point range at 20°C (68°F)
Differential	10 - 30% of setting
Weight	0.75 lbs (0.35 kg)

Differential Pressure Range

Model	Adjustment Range	
	PSID	BARD
1	10 - 30	0.7 - 2.0
2	25 - 60	1.7 - 4.0

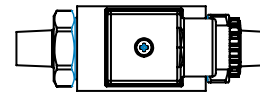

Dimensions

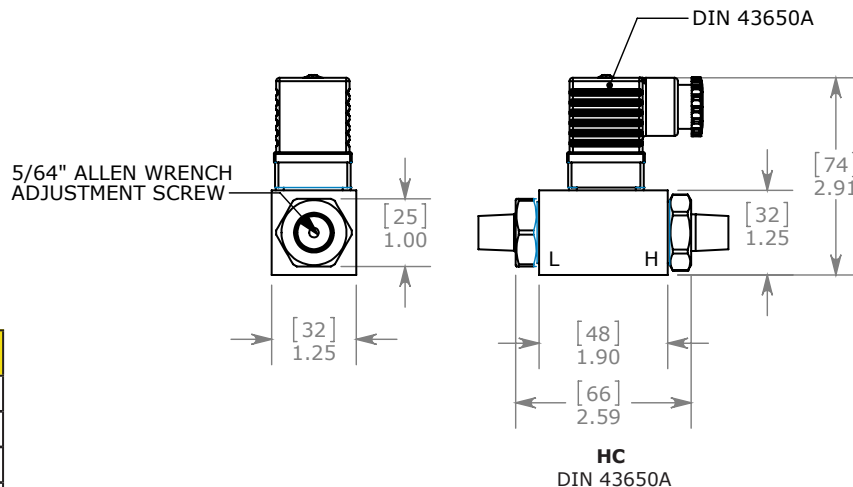

Wiring Code

CONTACT	DIN 43650 TYPE
COMMON	PIN 1
NORMALLY CLOSED	PIN 2
NORMALLY OPEN	PIN 3

Ordering Information

Field Adjustable **DSPA** - ¹**2** - ²**4M-4M** - ³**C** - ⁴**HC** - ^{5 (Optional)}**1**

Factory Preset **DSPF** - ¹**30F** - ²**4M-4M** - ³**C** - ⁴**HC** - ^{5 (Optional)}**1**

1 - Differential Pressure Selection:

Field Adjustable - Select Model Code

Insert set point value XXX followed by: R, F, BR, or BF

Model	Adjustment Range	
	PSID	BARD
1	10 - 30	0.7 - 2.0
2	25 - 60	1.7 - 4.0

OR

Set Point	Direction	Description
XXXX	R	PSI Rising Pressure
	F	PSI Falling Pressure
	BR	BAR Rising Pressure
	BF	BAR Falling Pressure

2 - Thread Options for both process connections:

4M-4M - 1/4 NPT male

4G-4G - 1/4 BSPP male, G1/4

3 - Circuit:

C - SPDT (Single Pole Double Throw : Normally Open and Normally Closed)

4 - Electrical Termination:

HC - DIN 43650A PG9/PG11 - connector type

HN - DIN 43650A 1/2" NPT Conduit

5 - Options (Omit if not required):

- 1** - Viton® Diaphragm
- 2** - EPDM Diaphragm
- 4** - HNBR Diaphragm
- 7** - Gold Contact, Snap Action Microswitch @ 20 mA / 12 VDC
- 8** - 10 amp, Snap Action Microswitch @ 10(2) 125 VAC (inductive), 6(2) 250 VAC (inductive)

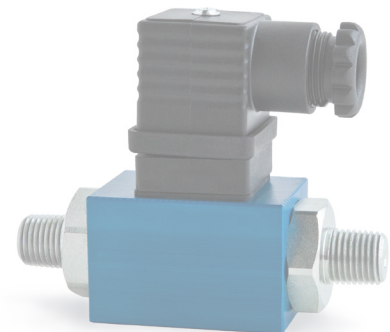

Note: Please see page 63 for other available options